

Cold Rooms 163x163 -2+8°C Built-in Unit

ITEM # _____

MODEL # _____

NAME # _____

SIS # _____

AIA # _____

102037 (CRR1616B7G)

 Cold Room 1630x1630
 th.60mm, included Unit

Short Form Specification

Item No.

Usable volume: 5.4 m³. Panel insulation in cyclopentane (60mm thickness), with injected polyurethane foam, CFC and HCFC free. Wall and internal ceiling surfaces made of galvanized plastified steel with 120 micron nontoxic pvc coating. Internal floor in non-slip, plastic coated, galvanized steel sheet. Fast-fit centering system using new fasteners made of high resistant composite material. Rounded internal and external corners. Self-closing right-hinged door with magnetic door-gaskets; handle with lock and interior safety release. Internal lighting. Built-in refrigeration unit for operation in ambient temperatures up to +43°C. Refrigerant R290. Defrosting through heated gas with automatic re-evaporation of defrosting water. Control panel with: ON/OFF switch, internal lighting switch and digital control with HACCP and failure alarms.

Main Features

- Very short assembly time. Expert refrigeration knowledge is not required for installation.
- Anti-slip walk-in floor.
- High hygiene standards and easy to clean thanks to rounded internal / external corners and radiused edges.
- Fast-fit centering system allows perfect alignment of the panels. These new fasteners are made of high resistant composite materials and guarantee perfect grip/sealing of all components.
- Floor surface on which the cold room will be placed should be levelled if presenting irregularities or unevenness up to 1 cm.
- New vacuum injection foaming allows significant and enhanced insulation and higher quality.
- Airtight panels connection, all sides of panels have PVC gasket foamed in place to assure airtight and secure fitting; any other sealing between panels on site is eliminated.
- Semi recessed door saving space on the external side.
- Newly designed handle complete with lock and interior safety release to prevent entrapment when the door is accidentally locked from outside.
- Defrosting through heated gas with re-evaporation of defrosting water permits to reduce the total power installed, shorten defrosting time and limit the warming of the cold room. Dedicated drain hole is not needed.
- Temperature controller with touch panel.
- Control panel includes: luminous ON/OFF switch, internal light switch, cold room functioning indicator, defrost cycle indicator, temperature and thermostat control with digital display.
- The unit is ready to be connected with OnE Connectivity for 24/7 real time monitoring, increasing equipment uptime, maximum profit and optimizing your process.
- Conform to ruling European safety and hygiene standards and CE marked.

Construction

- Panels are clad inside and outside with anti-scratch galvanized plastified steel with 120 micron nontoxic pvc coating, polyurethane foam insulation, CFC and HCFC free.
- Whenever the cold room door is opened the microswitch switches on automatically the internal light and turns off the cooling fan.

User Interface & Data Management

- Connectivity ready for real time access to

APPROVAL: _____

connected appliances from remote and HACCP monitoring (requires optional accessory).

Sustainability



- Hydrocarbon refrigerant gas R290 for the lowest environmental impact (GWP=3) - CFC and HCFC free.
- Right-hinged door is available as standard (left-hinged door on request) and constructed with smooth rounded profiles, cam-lift action hinges, airtight magnetic gasket and high insulation thus allowing to reduce energy and operating costs.

Optional Accessories

- Graphic temperature recorder PNC 102025
- Cold room datalogger PNC 102030
- Door microswitch PNC 102441
- Shelving Set, composed of aluminium uprights and 4 polyethylene louvered shelves, for 1630x1630 mm Cold Rooms

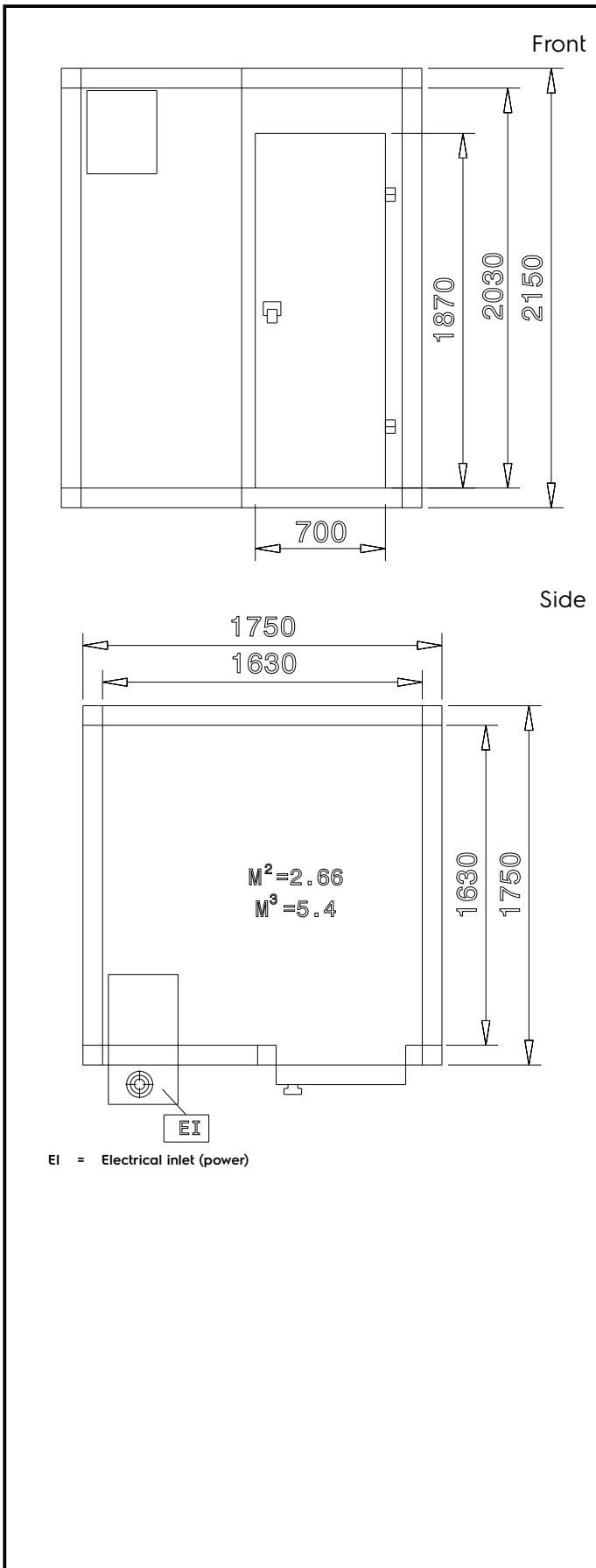

Electric

Supply voltage:	102037 (CRR1616B7G)	220 V/1N ph/50 Hz
Electrical power max.:		1.06 kW
Total Watts:		1.06 kW

Key Information:

External dimensions, Width:	1750 mm
External dimensions, Depth:	1750 mm
External dimensions, Height:	2150 mm
Internal Dimensions, Width:	1630 mm
Internal Dimensions, Depth:	1630 mm
Internal Dimensions, Height:	2030 mm
Net weight:	297.5 kg

Connectivity

Connection type:	Cable-RS485
Protocol type:	Care!;Modbus

Sustainability

Current consumption:	2.37 Amps
Refrigerant type:	R290
Refrigerant weight:	140 g